

AQUA[®]
LYTIC

AL20pH

pH-/Redox-/Temperature Meter
Operating instructions

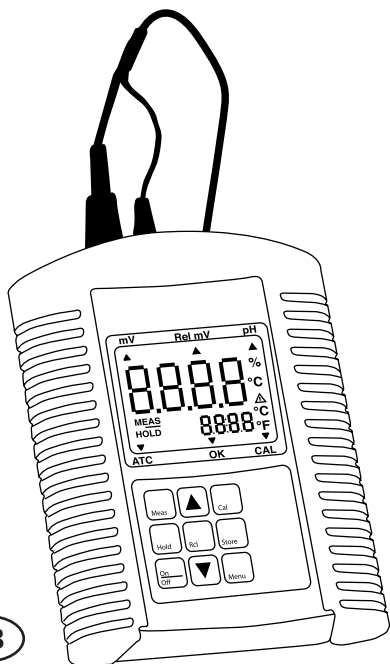



Declaration of CE-Conformity

The manufacturer:

Tintometer GmbH

Schleefstraße 8 a
44287 Dortmund
Deutschland

declares that this product

Product name:

AL20pH

with all optional items conforms to the following regulations:

EMC

EN 55 022 : 6 / 1993 class B
EN50082-1(EN61000-4-6,
EN 61000-4-4, EN 61000-4-3,
EN 61000-4-2)

**The product conforms to the regulations of the EMC Directive
89/336/EEC and 73/23/EEC.**

Dortmund, March 12, 2003

Cay-Peter Voss,
Managing Director

Table of Contents	Page
1. Scope of delivery	4
2. System description	4
3. Connections.....	5
4. Display	7
5. Keypad	7
6. Start up.....	8
7. Measurement.....	9
8. Configuration of the unit	11
8.1 Selection of measuring function [pH] – [mV] – [Rel mV]	11
8.2 Calibration: selection of calibration	12
8.3 Display of electrode status	12
8.4 Selection of temperature unit °C /°F	14
8.5 Power off: automatic unit switch-off	14
9. Calibration of pH measurement	14
9.1 Starting calibration: Press [CAL] key.....	16
9.2 Selecting buffer solutions	16
9.3 Calibration point 1: ,CAL. 1'	17
9.4 Calibration point 2: ,CAL. 2'	18
9.5 Calibration point 3: ,CAL. 3'	20
10. Result memory	21
10.1 Storing results	21
10.2 Displaying stored results	21
10.3 Deleting stored results.....	22
11. Error messages and troubleshooting.....	22
12. Technical data	25
13. Accessories	27

1. Scope of delivery

Standard:

- pH Meter
- Batteries, 4 x AA 1,5 V cells
- Operating instructions

Set:

- pH Meter
- Batteries, 4 x AA 1,5 V cells
- pH/Temperature sensor
- Standard buffer solutions, each 90 ml
pH 4.00/7.00/10.00
- Carrying case
- Operating instructions

2. System description

The system is a sturdy, water-tight handheld meter designed for daily measurements in the area of field or laboratory analysis.

It is used to measure redox voltage and temperature in the field of environmental analysis as well as for applications in the food and chemical industries.

The system complies with the requirements in EN 60529 relating to protection class IP67 and water-proof/dustproof properties.

The permanent protective plating on the unit serves not just as impact protection but also as a storage compartment for the electrode and as an anti-slip device when

the meter is used in an upright position.

Microprocessor technology and 4 x AA 1,5 V batteries allow unit operation without battery change for 15,000 hours or more.

A "Low Bat" indicator in the display shows the user when it is time to change the batteries.

The required temperature compensation for the system is performed automatically (ATC) following connection of a temperature sensor or via manual input via the touch-sensitive film keypad. The unit automatically identifies Pt1000 and NTC 30 kOhm sensors.

The AUTO HOLD feature enables the user to identify stable results and call them up on the display.

The MEAS function is the standard continuous measuring mode for pH levels or redox voltages.

pH calibration of the system is via an integrated automatic buffer recognition feature.

The temperature characteristics of the AQUALYTIC standard buffer solutions and the reference buffer solutions specified in DIN 19266 are stored in the unit and are used for automatic calibration of the system when selected.

It is additionally possible to enter some of the buffer data into the unit manually.

Calibration is performed optionally at 3 points, 2 points or 1 point.

A sensor evaluation is automatically shown in the display (or can be called up via the menu) after each calibration.

An internal memory for 20 results is integrated in the unit as standard. The memory stores location, result and temperature.

The memory is called up via the display.

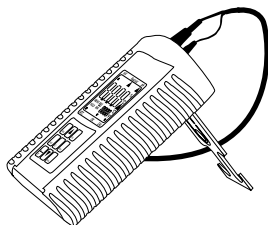
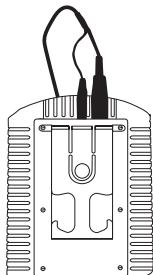

3. Connections

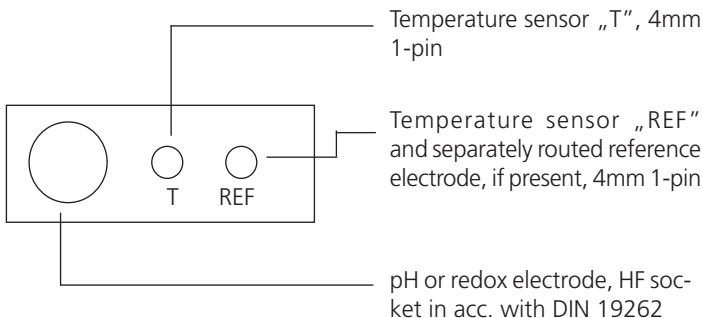

4. Display

Main display:	Result or user prompt
[mV]	Redox voltage, absolute
[Rel mV]	Redox voltage, relative to the hydrogen electrode (DIN 38404)
[pH]	pH level
Secondary display:	Result - temperature or user prompt
[%]	Percent (sensor evaluation)
[▲]	Warning index - battery/ one-point calibration
[°C, °F]	Temperature unit
[ATC]	Automatic temperature compensation
[OK]	Stable measuring signal
[CAL]	Calibration mode
[MEAS]	Measuring mode - standard
[HOLD]	Measuring mode - AUTO-HOLD

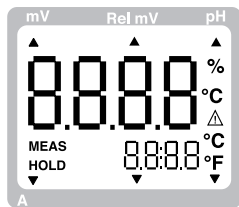

5. Keypad

Meas	Continuous measurement, (standard setting)
Hold	Auto Hold: automatic retaining of stable result
on/off	On/Off
[▲] [▼]	Leaf through menu or memory, manual temperature setting
Rcl	Display of stored results
Cal	Calibration mode
Store	Storage of current result or acceptance of unit configuration
Menu	Unit configuration



6. Start up

The unit is supplied with integrated batteries as standard and is therefore ready for immediate use.

You have to unscrew the unit to insert or change the batteries. When inserting the batteries, ensure correct polarity!

Screw the unit back together carefully without exerting too much pressure on the gasket seal.

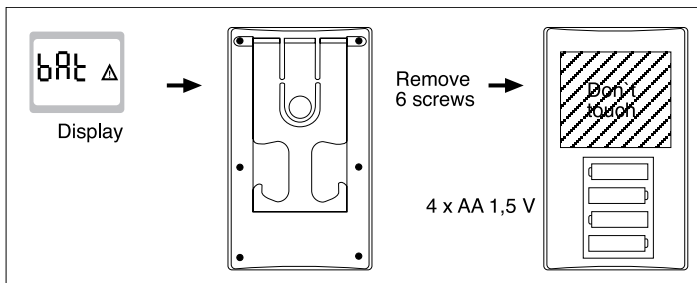

If the Δ symbol appears together with „bAt“ in the lower section of the display, this means that the batteries are nearly empty and need replacing.

However, the unit will continue to function for a certain period of time. If „bAt“ appears in the upper section of the display, this means that the batteries are completely empty.

Displayed values in the event of cable break or if no pH or redox electrode is connected:

If no electrode is connected or if the connecting cable is defective, the display still shows pH or mV results.

However, these results are not valid results!

The electrode or temperature sensor must be plugged in before the unit is switched on.

Switch the unit on via the [On/Off] key.

The system must be calibrated when the system is started up (see Calibration).



Following measurement, please switch the unit off using the [On/Off] key.

See the enclosed Operating Instructions for more detailed information on storage and care of the electrodes.

7. Measurement

Measuring mode MEAS

After the unit is switched on, it is automatically in the standard measuring mode MEAS.



You can switch to the standard MEAS measuring mode by pressing the [Meas] key.

The display shows the current, possibly still fluctuating result and MEAS. If the result is stable, the [ok] arrow appears in the display.

Measuring mode HOLD



Pressing the [Hold] key takes you into the AUTO HOLD measuring mode.

In this mode, the recorded result is checked by the system in line with the predefined stability criteria until these criteria are met.

The display shows Auto/Hold in alternating mode



together with the result.

Once a stable reproducible value is present, the result is shown permanently in the display („frozen“).

The display also shows HOLD and the automatically set or manually entered temperature.

If you press the [Hold] key again, the measuring cycle starts anew and runs until the stability criteria are met.



Temperature measurement, automatic temperature compensation (ATC)

During pH measurement and redox measurement (relative to the hydrogen electrode [Rel mV]), it is necessary to compensate for the temperature effect of the electrode.

If a temperature sensor is connected, temperature compensation is performed automatically (ATC = automatic temperature compensation).

The unit can automatically distinguish between a Pt1000 and an NTC30kOhm temperature sensor.

The sensor type is displayed if you simultaneously press the [Meas] and [Hold] keys.



If a temperature sensor is not connected, you must manually enter the temperature of the medium to be tested using the [▲][▼] keys after switching on the unit and confirm the value by pressing the [Store] key.



During the measurement process, you can change the temperature value at any time using the [▲][▼] keys.

In the HOLD measuring mode, a new Auto Hold measurement is started automatically every time a change is made.

8. Configuration of the unit



To configure the unit, press the [Menu] key. The first menu item appears.

If you press the [Menu] key again, the display jumps to the next menu item.



You can set the various parameters using the [▲] [▼] keys.



Press the [Store] key to store and conclude configuration.

The unit then switches back to measuring mode.



You can terminate the configuration process by pressing the [Meas] or [Hold] key.

Settings made up to this point are not stored.

The unit retains the previous settings.



8.1 Input: selection of measuring function [pH] – [mV] – [Rel mV]

Select the desired measuring function using the [▲] [▼] keys. The arrow in the display shows the selected function.



- pH: pH measurement with pH electrode
- mV: redox measurement with redox electrode
- Rel mV: redox measurement with redox electrode. The displayed value is converted to the normal hydrogen system in temperature-dependent mode (DIN 38404).



8.2 CAL = Calibration: selection of calibration (only with pH function)

You can choose between 1, 2 and 3-point calibration.



1-point calibration:

Calibration of the pH electrode is performed at a random point.

The electrode slope is always based on the theoretical slope of -59.2mV/pH .

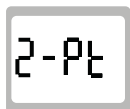

2-point calibration:

Calibration of the pH electrode is performed at two points.



3-point calibration:

Calibration of the pH electrode is performed at three points.



8.3 Display of electrode status (only with pH function)

Indication of the electrode status that is computed internally during every calibration depending on the electrode used.

- 100% The electrode is in excellent condition.
- 30...90% The condition of the electrode is adequate.
- <30% The electrode is old or soiled.

If there is no improvement after you have cleaned and recalibrated the electrode (see operating instructions for electrode), you need to replace the electrode.

Percentage calculation of the electrode status is based both on asymmetry potentials and on slopes (gradient of the pH characteristic) of the electrode. The electrode condition is then determined by the worst result. The admissible characteristic data of the pH electrodes are as follows:



Asymmetry potential of the electrode at 25°C in mV

Max. admissible range: +30...-30 mV
Optimum: 0 mV

Soiling of the electrode can have a major adverse effect on asymmetry.

[SL] = Slope of the electrode signal at 25°C in mV/pH

Admissible range: -62...-50 mV/pH
Optimum: -59,2 mV/pH



1-point calibration is always based on the optimum theoretical value of -59.2mV/pH. The slope is not shown in the menu.

For 2-point calibration, the slope is specified for the entire measuring range.



For 3-point calibration, the slope is first displayed for the lower, acid measuring range [SL. 1] and then for the upper, basic range [SL. 2].

Unit

8.4 Selection of temperature unit °C /°F

- °C All temperature values in degrees Celsius
- °F All temperature values in degrees Fahrenheit
($^{\circ}\text{C} = 0.556 \cdot ^{\circ}\text{F} - 17.8$ or $^{\circ}\text{F} = 1.8 \cdot ^{\circ}\text{C} + 32$)

P.off

8.5 Power off: automatic unit switch-off

If no key is pressed during the switch-off delay period, the unit switches off automatically after the selected time has run down.

The desired delay time is entered in minutes.

If P.off = off, automatic unit switch-off is inactive.

9. Calibration of pH measurement

The individual sensor characteristics of pH electrodes are affected by ageing which causes fluctuations.

This is why, prior to measurement, it is important to check the current system calibration using buffer solutions to ensure optimum measuring results.

If the calibration deviates from the ideal setting by more than a certain amount, you need to recalibrate the system.

Buffer solutions are liquids that possess an exact, reproducible pH level.

Calibration can be performed using buffers in the:

- AQUALYTIC standard series (25°C): pH 4.00, pH 7.00 and pH 10.00
- DIN 19266 series (25°C):
pH 1.68 (A), pH 4.01 (C), pH 6.87 (D), pH 9.18 (F)
and pH 12.45 (G)
- or using any user-selectable buffers

The shelf life of buffer solutions is limited and is shortened further by, among other things, inadequate cleaning and drying of the electrode prior to insertion. This can lead to incorrect calibration! You should therefore always use fresh buffer solutions for calibration wherever possible and clean the electrode using deionised or distilled water!

Automatic temperature compensation for calibration

Both the pH electrode signals and the pH buffer values are temperature-dependent. If a temperature sensor is connected, the temperature effect of the electrode is compensated automatically during measurement and calibration.

Otherwise, you need to enter the actual temperature of the buffer as accurately as possible during calibration. If you use the AQUALYTIC standard buffer series or the DIN buffer series, the temperature effects of the buffers are additionally compensated.

To ensure maximum precision of calibration in the event of manual buffer selection, you should enter the pH values of the buffers at the corresponding temperature.

Performing calibration

If you have not already done so, select the measuring mode ,pH' (see Configuration) and ensure that (depending on your requirements), 1-point, 2-point or 3-point calibration is active in the configuration setting

Carefully remove the protective cap from the electrode.

Clean the electrode using deionised water and dry carefully.

9.1 Starting calibration: Press [Cal] key.



'CAL' appears momentarily in the display.

You can terminate calibration at any time by pressing the [Meas] key or [Hold] key. In this event, the previous calibration setting is retained.

9.2 Selecting buffer solutions

'buFF' is shown in the main display.



You can choose between the various buffer series using the [▲] [▼] keys.



You then confirm the selected buffer set by pressing the [Store] key.

The following inputs are possible:



AQUALYTIC standard series

Values at 25°C: 4.00pH, 7.00pH, 10.00pH



DIN 19266 series

Values at 25 °C: 1.68pH(A), 4.01pH(C), 6.87pH(D), 9.18pH(F), 12.45pH(G)



Manual buffer setting

If you want to use buffers other than those in the AQUALYTIC standard or DIN series, you can choose manual buffer adjustment here.

9.3 Calibration point 1: ,CAL. 1'

Insert the electrode and the temperature sensor (if present) in buffer solution 1 (e.g. AQUALYTIC standard buffer solution pH 7.00) and swirl carefully.

In the case of manual buffer setting, [Pt.1] appears in the secondary display.



You enter the pH value of the buffer solution using the [▲] [▼] keys.



You then confirm the input by pressing the [Store] key.

When AQUALYTIC standard and DIN series solutions are used, the system automatically detects the pH value of the solution.

[CAL.1] appears in the secondary display until the value is stable; the detected value is then automatically stored .

You are then requested to perform the next calibration step.



Without temperature sensor: manual input of temperature of solution 1

You can enter the actual temperature of the buffer solution using the [▲][▼] keys.



The value is stored when you press the [Store] key, and the system shows the next calibration step.



In the case of 1-point calibration, the status of the electrode is then displayed (only asymmetry potential, slope optimal = 59.2 mV/pH); the unit then switches to the standard measuring mode MEAS.

After 1-point calibration, the ▲ signal is permanently shown in the display.

The user should be aware that measuring errors can occur with 1-point calibration, particularly with results that are a long way from the calibration point.

2-point calibration is therefore always advisable.

Clean the electrode using deionised water and dry carefully.

9.4 Calibration point 2: ,CAL. 2' (only with 2-point and 3-point calibration)

Insert the electrode and the temperature sensor (if present) in buffer solution 2 (e.g. AQUALYTIC standard buffer solution pH 4.00).



In the case of manual buffer setting, [Pt.1] appears in the secondary display. You enter the pH value of the respective buffer solution using the [▲][▼] keys. You then confirm the input by pressing the [Store] key.



When AQUALYTIC standard and DIN 19266 series

solutions are used, the system automatically detects the pH value of the solution.

If the display flashes and switches between different buffers, this means that no valid buffer has been detected.

[CAL.2] appears in the secondary display until the value is stable; the detected buffer value is then automatically stored.

You are then requested to perform the next calibration step. In the case of 2-point calibration, the status of the electrode is then displayed (asymmetry potential and slope); the unit then switches to the standard measuring mode MEAS.



Without temperature sensor: manual input of temperature of solution 2

You can enter the temperature of the second buffer solution using the [▲] [▼] keys.



The value is stored when you press the [Store] key, and the status of the electrode is displayed.



Clean the electrode using deionised water and dry carefully.

9.5 Calibration point 3: ,CAL. 3' (only with 3-point calibration)

Insert the electrode and the temperature sensor (if present) in buffer solution 3 (e.g. AQUALYTIC standard series pH 10.00).



In the case of manual buffer setting, [Pt.1] appears in the secondary display. You enter the pH value of buffer solution 3 using the [▲][▼] keys. You then confirm the input by pressing the [Store] key.

When AQUALYTIC standard and DIN 19266 series solutions are used, the system automatically detects the pH value of the solution.

If the display flashes and switches between different buffers, this means that no valid buffer has been detected.

[CAL.3] appears in the secondary display until the value is stable; the detected buffer value is then automatically stored.

In the case of 3-point calibration, the status of the electrode is then displayed (asymmetry potential and slope); the unit then switches to the standard measuring mode MEAS.



Without temperature sensor: manual input of temperature of solution 3



+



You can enter the temperature of the third buffer solution using the [▲] [▼] keys.



The value is stored when you press the [STORE] key, and the status of the electrode is displayed.

N.B.:

A flashing display during manual buffer value input means that the selected buffer pairs are numerically too close. The difference between two buffer solutions must be at least pH 2.00.

10. Result memory

A maximum of 20 results with the corresponding temperatures can be stored.

10.1 Storing results



You can store the current result in the result memory by pressing the [Store] key.

[Stor] and the number of the memory location appear briefly in the display.

10.2 Displaying stored results



You can call the stored results up in the display by pressing the [RCL] (=Recall) key.

The first time you press the [RCL] key, the number of the memory location and the corresponding pH or voltage value (redox value) are displayed.

The second time you press the key, the temperature for this result is displayed.

You can use [▲] [▼] keys to switch between the stored results.

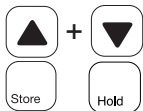

As soon as you press the [STORE], [MEAS] or [HOLD] key, the unit reverts to the corresponding measuring mode.

10.3 Deleting stored results

If you press the [Store] key for longer than 2 seconds, the unit switches to the delete menu [CLR].





You can use the [▲][▼] keys to select the desired action and press the [Store] key to execute it.



The unit then returns to the corresponding measuring mode.

- [CLr-ALL]: delete all stored results.
- [CLr-LAST]: delete the last-stored result.
- [CLr-no]: do not delete any result.

11. Error messages and troubleshooting

Display	Cause	Remedy
	Weak battery voltage the unit will only continue to function for a short time	Insert new batteries
	Batteries empty	Insert new batteries

Display	Cause	Remedy
	Memory full	Delete memory
No display or strange symbols. Unit does not react when keys are pressed	Batteries are empty	Insert new batteries
	Batteries incorrectly inserted	Check batteries
	System error	Disconnect batteries, wait for a short time, reconnect the batteries
	Unit defective	Send in for repair
Err.1	Exceeds measuring range	Check: can value exceed admissible measuring range? -> Result too high!
	Sensor/Electrode defective	Replace sensor/ electrode
Err.2	Below measuring range	Check: can value be below admissible measuring range? -> Result too low!
	Sensor/Electrode defective	Replace sensor/ electrode
Err.7	System error	Send in for repair
Err.11	Value could not be calculated	Temperature outside the admissible temperature measuring range

pH-Kalibration

CAL.-Err.1	Asymmetry inadmissible: Electrode defective	Clean electrode, re-calibrate If error repeated -> replace electrode
	Buffer solution unusable	Use fresh buffer solution
CAL.-Err.2	Slope too small Electrode defective	Replace electrode
	Buffer solution unusable	Use fresh buffer solution
CAL.-Err.3	Slope too big Electrode defective	Replace electrode
	Buffer solution unusable	Use fresh buffer solution
CAL.-Err.4	Wrong temperature during calibration	Calibration only possible in range from 0..60°C

12. Technical data

• Indicating ranges:

Temperature	-10,0 ... +110,0°C / 14.0 ... 230.0°F
Resolution	0,1°C bzw. 0.1°F
pH	0,00 ... 14,00 pH
Resolution	0,01 pH
Redox (ORP)	-1999 ... +2000 mV
	- 1792 ... +2206 Rel mV (based on hydrogen system in acc. with DIN38404)
Resolution	1 mV

• Accuracy:

(at nominal temperature, unit ± 1 digit)

Temperature	$\pm 0,2^\circ\text{C}$ (0..50°C), otherwise $\pm 0,4^\circ\text{C}$
pH	$\pm 0,01$ pH
Redox	$\pm 0,1\%$ FS (mV bzw. Rel mV)

- **Temperature-compensation** With temperature sensor, automatic temperature compensation (ATC) is performed in the measuring modes „pH“ and „Rel mV“. Without temperature sensor, the temperature must be entered manually.

• Sensor connections:

Temperature	two 4mm 1-pin sockets „Temp“ and „Ref“ temperature sensors Pt1000 and NTC30k
pH, Redox	DIN19262 socket, separate reference electrode is connected to „Ref“ input impedance: $>10^{12}$ Ohm (typ.)

- **Input current:** <1 pA
- **Nominal temperature:** 25°C
- **Operating temperature:** 0 to +50°C
- **Storage temperature:** -20 to +70°C
- **Memory:** 20 result memory locations
- **Power supply:** 4* 1.5V batteries, type AA. Operating life up to >15000h (depending on measuring mode and battery type)
- **Power consumption:** max. 0.2 mA (depending on measuring mode)
- **Battery change indicator:** 'bAt'
- **Automatic „Off“ function:** if no key is pressed and no data transfer is occurring, the unit switches off after the switch-off delay time. May be set between 1 and 120 minutes or inactive.
- **pH-Calibration:** 1-point, 2-point or 3-point calibration standard buffer, DIN buffer or user-selected buffer
- **Automatic buffer recognition:** temperature dependence of standard or DIN buffer is automatically compensated. Admissible electrode data:
 - asymmetry: ± 30 mV
 - slope: -62...-50 mV/pH
 sensor evaluation based on calibration result (from 10 to 100%).
- **Recommended redox electrodes:** reference system: silver/silver chloride, electrolyte: KCl, 3 mol/l (only use this type when converting to hydrogen „Rel mV“ !)
- **CE** EN 55022: 6/1993 class B, EN 50082-1 (EN 61000-4-6, EN 61000-4-4, EN 61000-4-3, EN 61000-4-2)

13. Accessories

4721200	AQUALYTIC AL20pH Basic instrument
4721220	AQUALYTIC AL20pH Set with Sensor Type 230
721225	pH Electrode Type 225, plastic, gel-filled
721230	pH Electrode Type 230 with temperature Sensor NTC 30 kOhm, plastic, gel-filled
721235	pH Electrode Type 235, glass, gel-filled
721240	ORP Electrode, Type 240, plastic, gel-filled
721245	Temperatur Sensor Pt 1000
721250	pH Buffer-Set 4.00/7.00/10.00 (25°C)
721252	pH Buffer 4.00 (25°C) 1 Litre
721254	pH Buffer 7.00 (25°C) 1 Litre
721256	pH Buffer 10.00 (25°C) 1 Litre
721260	Adapter DIN19262 - BNC
721265	Adapter cable DIN19262 - S7 plug-head
725020	Case AL20

AQUALYTIC®
Schleefstraße 12
D-44287 Dortmund
Phone: (+49) (0)231 / 9 45 10 - 755
Fax: (+49) (0)231 / 9 45 10 - 750
sales@aqualytic.de
www.aqualytic.de

Germany



Technical changes without notice
Printed in Germany 09/09
No.: 38 60 70
AQUALYTIC® is a registered
trademark of the
Tintometer group of companies